

# The 1802 Membership Card

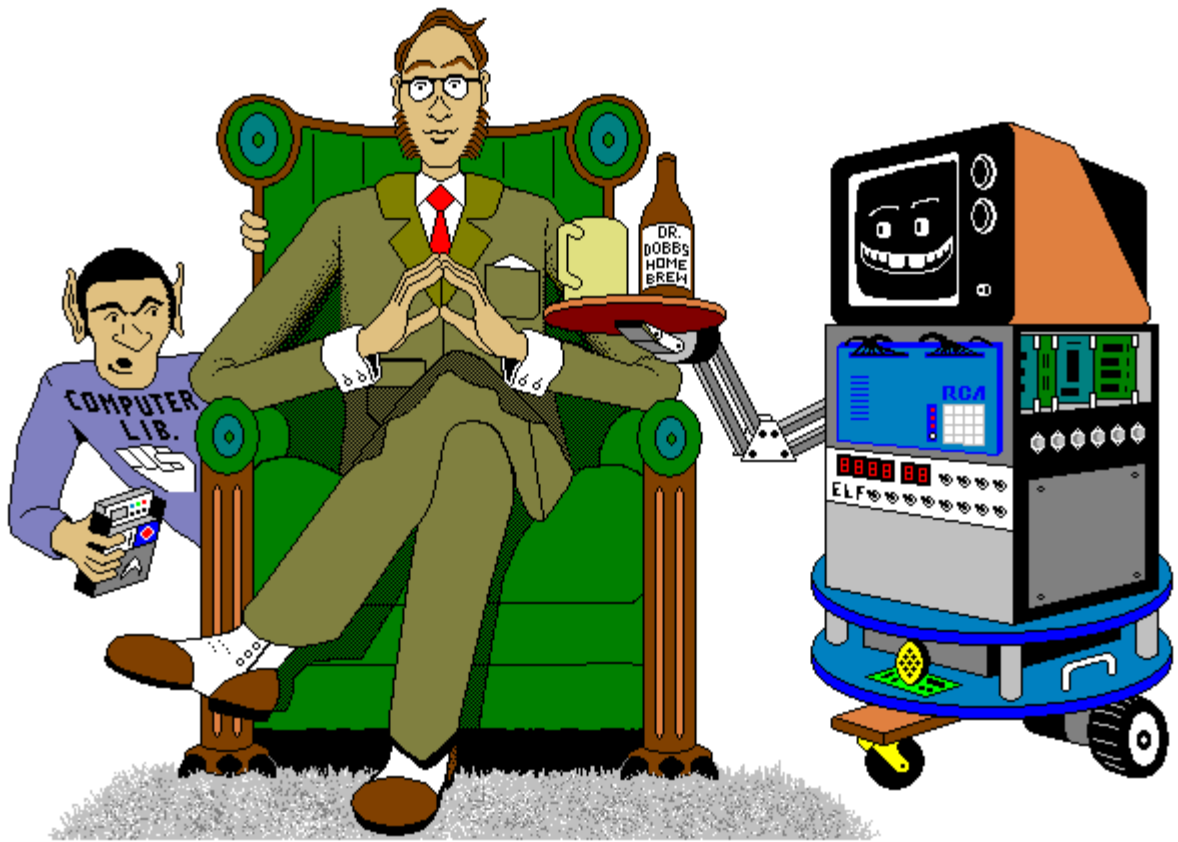

For me and you and the 1802

by Lee Hart  
814 8th Ave N  
Sartell MN 56377  
leeahart@earthlink.net  
last revised: 5/25/2013

What the heck is this? It's an adventure, by cracky! The "Membership Card" is your ticket to the weird and wonderful world of microcomputing. Our guide will be the COSMAC 1802, perhaps the oddest and most entertaining microprocessor yet invented. I hope you will find this manual to be equally odd and entertaining.

The COSMAC 1802 was created in the 1970's at the dawn of the microcomputer revolution, by Joseph Weisbecker of RCA Corporation. It used their new CMOS fabrication process, which had very low power consumption, high noise immunity, and was very simple to use. It was intended for military and aerospace; applications too tough for other microcomputers to survive.

But Joe was a hacker at heart. He wrote a series of articles starting in the August 1976 issue of Popular Electronics magazine called "Build the COSMAC ELF". It described a simple low-cost computer, using the 1802 microprocessor. At the time, microcomputer systems cost hundreds to thousands of dollars. (Hmm... they still do today!) But Weisbecker's ELF cost less than \$100! Yet, it was an honest-to-goodness real live computer, able to do anything its much bigger cousins could do -- albeit a bit slower and cruder.

It was the ideal computer trainer. Hobbyists built thousands of ELFs, learning about computer design, construction, and programming in the process. A dozen companies began producing versions of the ELF, also selling for low prices. It was the "Legos" of computers; a simple building-block computer that could be assembled many ways to become almost anything, limited only by your imagination.

I learned about computing on my ELF. It set me on a career in engineering, as it did for thousands of others. 1802's were designed into all sorts of amazing things; video games, music synthesizers, Chrysler engine computers, military weapon systems, and even NASA missions such as the Galileo spacecraft. Eat stardust, x86 PCs!

So return with me now to those thrilling days of yesteryear, when the heroic pioneers of the microcomputer revolution learned how to build their own computers from scratch, and programmed them to do incredible things, all for a tiny amount of money!

## What can you do with an 1802?

The Membership Card is much like the Arduinos and Parallax BASIC Stamps. You can program it to do simple tasks, and be the "brains" of various projects. It can blink lights, drive relays or small motors, run displays, make annoying sounds with a speaker, read switches or sensors to measure things, perform calculations, make decisions, and more. Its machine language is very simple, and free assemblers are available. There are also open source BASIC interpreters and C compilers for the 1802 to write and run really ambitious programs.

Once a program is loaded, it can be retained without power for a short time by the onboard supercapacitor, or indefinitely by maintaining power. Remember, this is a low power computer; it will run for a year on three AA cells!

The Front Panel can be unplugged, and the Membership Card used by itself (like a Parallax BASIC Stamp). The Front Panel isn't needed until you want to change the program, or debug or observe operation. For stand-alone use, connect power, ground, and your desired input and output devices to the 30-pin header directly. Jumper J1 pins 13-14 (RUN to VDD) to turn it on. Jumper pins 10-11 (/WE to /MWR) to enable writing to memory.

## Specifications: What have we got here?

The Membership Card is a miniature copy of the original Popular Electronics ELF, built using modern parts and repackaged to fit in an Altoids tin. It's got the basics of every computer; a CPU, memory, and I/O.

- CPU: RCA CDP1802ACE microprocessor (the brains of the outfit)
- Clock: 1.8 MHz ceramic resonator, plus RC oscillator adjustable from 20-2000 KHz (no, not MHz or GHz)
- Memory: 2k to 32k bytes, RAM or EPROM (that's kilobytes, not megabytes)
  - supercapacitor holds data and programs in RAM without power
- I/O:
  - one 8-bit output port, with LEDs
  - one 8-bit input port, with switches
  - one 1-bit output, with LED
  - four 1-bit flag inputs, one with a pushbutton switch
  - one interrupt input
- Connectors:
  - 4-pin power connector (+V, RUN, LED, and -V)
  - 25-pin DB25 connector with all the I/O and power on it
  - DB25 can plug into a PC parallel port to operate the Membership Card with the PC
- Size: 3-1/2" x 2-1/8" x 3/4" (89 x 54 x 19 mm)
- Power:
  - voltage: 3v to 5v DC
  - current: 0.1 to 2ma (depending on clock speed and supply voltage)
  - plus 1-3ma for each LED that is on
- Aroma: a hint of curiously strong peppermint

Unlike modern microcomputers that require an expensive PC and huge software programs to do anything, the Membership Card is totally self-sufficient. No PC is needed, and no special software is required. You can power it from a few AA cells or a scrapped calculator solar panel, and program it with nothing but the front panel switches and lights. If you ever get stranded on a desert island and need to compute, this is the computer to have in your pocket.

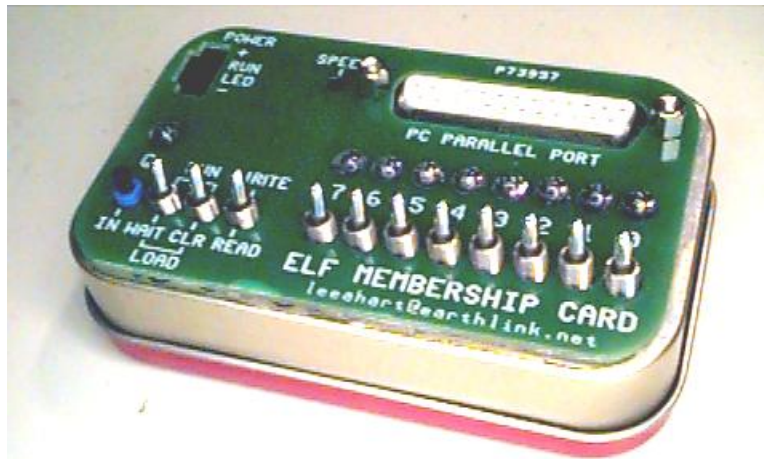

The complete package: Membership Card, Front Panel, and Cover Card, all fit in an Altoids tin.

## Assembly: Getting it all together

This ain't no Heathkit, but I'm working to make it as easy to build as possible. I want it to be something you can give to your kids, and have them experience the thrill of saying, "I did it! It's alive! Bwoo hah hah hah..."

To assemble it, you'll need the following tools:

- A clean, well-lit, place to work. Preferably one without cats or small children.  
Or if the kids are old enough, let them help. (Cats are never old enough to help.)
- Soldering iron with a small tip. Don't use a soldering gun unless you're desperate; soldering these tiny parts and pads with a big fat tip will be a real challenge.
- Solder. 63/37 tin/lead is best, but 60/40 is also good. Lead-free electronics solder is also OK, though it doesn't solder as well. It **must** be rosin core electronics solder; NOT acid core plumbing or sheet metal solder!
- Wire cutters. The smaller the better. Nothing is big here.
- Needle-nosed pliers. For bending or straightening lead wires, holding nuts, etc.
- Screwdriver with a 1/8" wide or smaller blade. For tightening mounting screws and adjusting the clock frequency pot.
- A magnifying glass. My old eyeballs aren't good enough to read the markings on some of the parts, or see whether a solder joint is done right or is shorted to the pad next to it.  
Your eyes may not be that good, either.

You'll need to know how to solder. This isn't the right kit to learn how to solder. The pads are pretty small, and if you make a mistake, it can be a real bear to get the part off and put back on the right way.

First, make sure you have all the parts. I supplied everything that goes on the printed circuit boards, but you may need to gather a few other things yourself. I'll supply Altoids tins as long as my supply holds out, but you will have to drill or cut the holes in it for the switches, LEDs and connectors.

The Membership Card is your entry into the **COSMAC College of Computer Knowledge**. We'll start with an aptitude test. See if you can find and identify the common electronic components listed on the next page. Place a check mark in the box ( X ) as you find them. If any are missing, let me know so I can send it out before you get bored and go back to watching TV. Ready? Turn the page to begin an adventure that could last a lifetime...

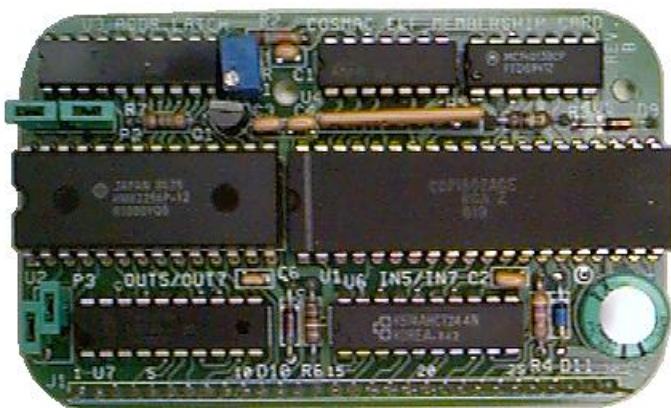

Membership Card

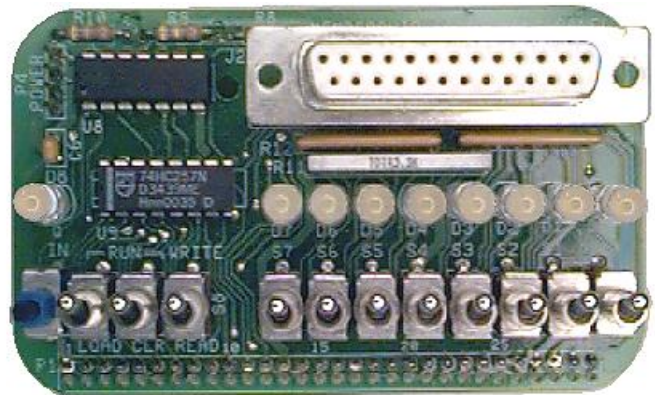

Front Panel Card

## Parts List

<u>Quantity</u>	<u>Identifier</u>	<u>Description</u>	<u>Source</u>
( ) 1	C1	ceramic resonator, 1.8 MHz (orange, marked 1.80MG)	Mouser 520-ZTT200MG
( ) 4	C2-4,7	capacitor, 0.1uF X7R ceramic (yellow, marked 104)	Jameco 544868
( ) 1	C5	supercapacitor, 0.22F, 5.5vdc (black disk, 0.4" dia.)	Digikey P10788-ND
( ) 1	C6	capacitor, 100pF ceramic (yellow, marked 101)	Jameco 81525
( ) 9	D0-8	LED, T1-3/4, red	Jameco 253753
( ) 3	D9,10,12	diode, 1N4148	Jameco 36038
( ) 1	D11	diode, 1N5231B 5.1v zener (standard) or 1N4625 5.1v zener (optional; lower power)	Jameco 179047 Mouser 610-1N4625
( ) 3	J1a,b,c	10-pin top entry socket, Molex 22-18-2101	Digikey WM3241-ND
( ) 1	J2	25-pin connector, DB25 female, vertical PC mount	Jameco 15165
( ) 1	P1	30-pin header, 0.025" sq.pins on 0.1" centers	Jameco 103342
( ) 1	P2	5-pin header, 0.025" sq.pins on 0.1" centers	Jameco 2076789
( ) 1	P3	4x2 pin header, 0.025" sq.pins on 0.1" centers	Jameco 109517
( ) 1	P4	4 pin header, 0.025" sq.pins on 0.1" centers	Jameco 117560
( ) 1	Q1	MOSFET, N-channel 2N7000 (3 leads, black)	Jameco 119423
( ) 1	R1	1meg trimpot, Bourns 3266W (3 leads, blue cube)	Jameco 696386
( ) 2	R3,6	resistor, 100k 1% 1/4w (brown-black-black-orange-violet)	Jameco 691340
( ) 4	R4,8-10	resistor, 499k 1% 1/4w (yellow-white-white-orange-brown)	Jameco 691500
( ) 1	R5	100k 9-pin SIP, 8x100k (black body)	Mouser 652-4609X-1LF-100K
( ) 1	R7	resistor, 1meg 5% 1/4w (brown-black-green-gold)	Jameco 691585
( ) 1	R11	1k 10-pin SIP, 9x1k (black body)	Jameco 97877
( ) 2	R12,13	100k 8-pin SIP, 7x100k (black body)	Jameco 276358
( ) 1	R14	resistor, 6.8k 1% 1/4w (blue-gray-black-brown-brown)	Jameco 691067
( ) 11	S0-10	subminiature toggle switch, SPDT	Digikey CKN1091-ND
( ) 1	S11	subminiature pushbutton switch, SPDT	Digikey CKN1740-ND
( ) 1	U1	1802 microprocessor	
( ) 1	U2	RAM: 6116 (2k), 6264 (8k), 62256 (32k), or 43256 (32k) (or EPROM: 2716-27256 or 27C16-27C256; 2k-32k)	
( ) 68		socket pins for U1 and U2	Digikey ED5037-ND
( ) 1	U3	74HC373 or 74HCT373 octal latch	Jameco 45831
( ) 1	U4	4093 quad 2-input NAND	Jameco 13400
( ) 1	U5	4013 dual D flip-flop	Jameco 893443
( ) 1	U6	74HC244, 74HCT244, or 74AC244 octal buffer	Jameco 45655
( ) 1	U7	74HC374 or 74HCT374 octal D flip-flop	Jameco 45858
( ) 1	U8	4071 quad 2-input OR	Jameco 13274
( ) 1	U9	74HC257 or 74HCT157 quad data selector	Jameco 272170
( ) 1	PCB	Membership Card and Front Panel circuit boards (rev.E)	
( ) 1		"Altoids" tin candy box	
( ) 1		bag of #4 hardware to mount J2 (2 jackscrews, 2 nuts, 6 washers)	
( ) 4		jumpers for P2 and P3 headers	Mouser 737-MSB-G

Did you find them all? Here are some hints:

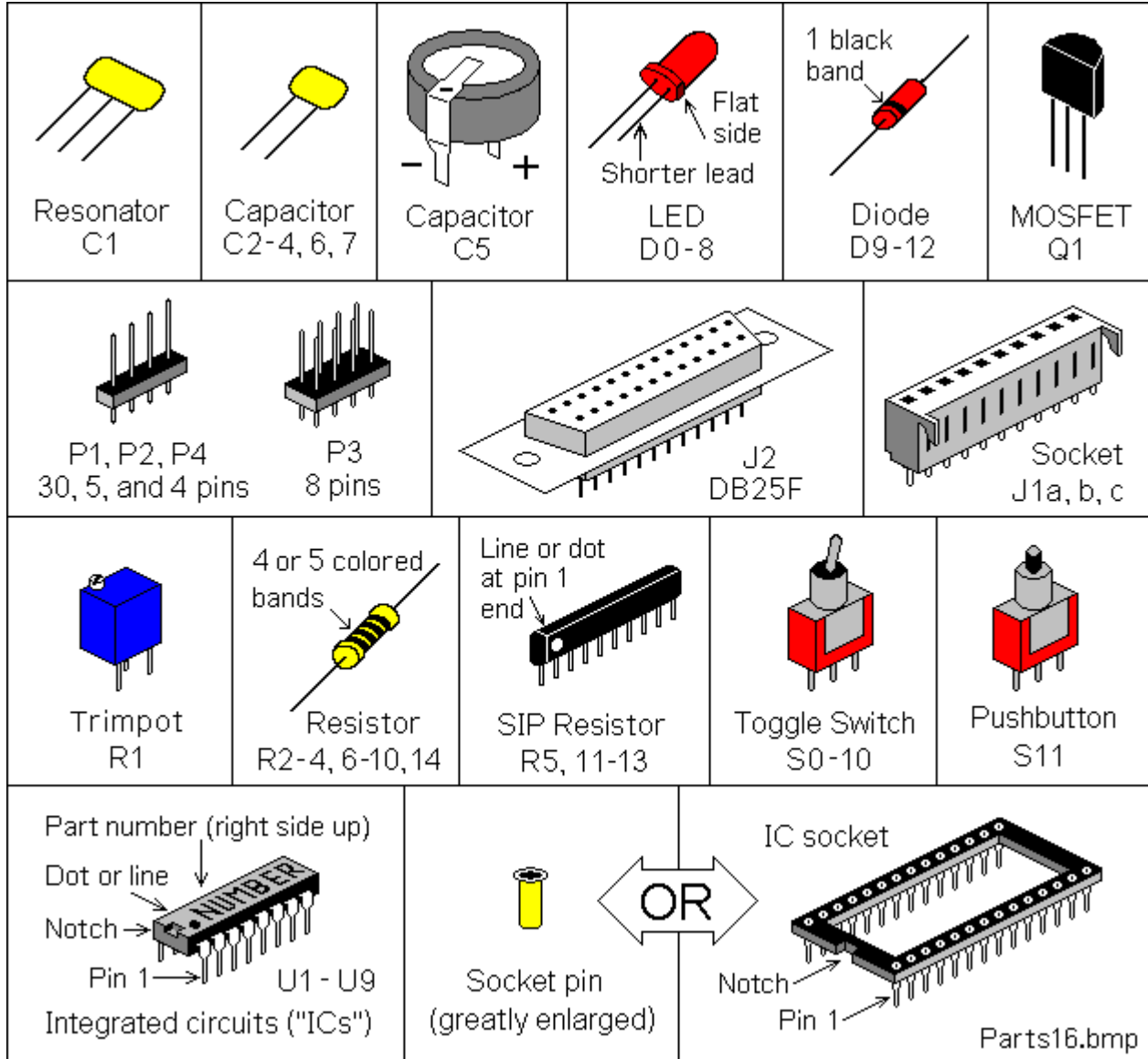

## Comments on components

The resistors use colored rings to identify their resistance. The other parts have numbers, but you may need a magnifying glass to read them. Capacitors have their value in Farads (usually picoFarads). For example, "22" is 22pF (22 picoFarad). "101" is 10 with one zero after it, i.e. 100pF. "104" is 10 with four zeroes after it; that's 100,000pF = 0.1uF (microFarad).

ICs have room for a part number, but it's hidden between extra letters (i.e. the 1802 is CDP1802ACE). Leave the ICs in their packaging until you're ready to install them. They are easily damaged by static electricity. You know that tiny little spark you get if you touch something metal after petting the cat or walking across a carpet? That's static electricity. In the microscopic world inside an IC, it hits like a lightning strike. **BOOM!** Your IC is dead.

# Assembly

Assembly is a work in process. I'll just describe how I built mine. Please let me know if you find better ways to do it! Check off the steps as you go ( X ), in case you get interrupted and have to come back to it later.

A couple things to keep in mind: To fit both boards in an Altoids tin, they must be built with the parts as low as possible. Standard IC sockets are too high, so I've supplied special low-profile socket pins. Likewise, the plastic bodies of the 0.025" square pin headers (J1, P2-4) make them too tall, so they have to be removed after soldering. You'll also need to trim the leads on the back side of the boards very short as you go.

Ready? Let's get started!

## Membership Card assembly

All parts go on the side of the board with the white silkscreened lettering (the top or "component side"). All soldering is done on the other side (the back or "solder" side). The only exception is for P1a, b, and c (I'll remind you when we get to it).

- ( ) Find C1; a 1.8 MHz ceramic resonator (orange body, labelled "1M80MG"). Insert the leads into the holes on the board in the box at the location marked "C1". Bend the leads outward slightly to hold it on the board. Turn the board over, and solder each lead. Cut off the excess lead length.

Capacitors have two leads, but are installed pretty much just like C1. If the leads are bent, straighten them with your needle-nosed pliers. Then repeat the procedure for C1 to install each of the capacitors.

- ( ) C2: 0.1uF (yellow, marked "104").
- ( ) C3: 0.1uF (yellow, marked "104").
- ( ) C4: 0.1uF (yellow, marked "104").
  
- ( ) C6: 100pF (yellow, marked "101"). Note: This one is smaller and different from C2-C4. Don't get them mixed up!
  
- ( ) C5: 0.22F (black disk, marked "0.22F"). It has two flat leads, one from the top and one from the bottom. The flat lead on top has a "-" sign stamped into it. This lead goes into the hole near the "-" and "C5" markings; closest to the corner of the board.

Now for the resistors:

- ( ) Find R1; it's a 1 megohm trimpot (a little blue cube with 3 leads, marked "W105"). Put it at location "R1", bend the leads to hold it, solder them, and cut off the excess.
- ( ) R3: a 100k ohm 1% resistor (gray body, with brown-black-black-orange-violet color bands). Bend the leads close to the body. Insert the leads into the holes on the board at the location marked "R3". Bend the leads outward slightly to hold it, solder each lead, and cut off the excess.

Repeat this procedure for the rest of the resistors.

- ( ) R4: 499k 1% (brown body, with yellow-white-white-orange-brown bands).
- ( ) R6: 100k 1% (gray body, with brown-black-black-orange-violet bands).
- ( ) R7: 1 meg 5% (tan body, with brown-black-green-gold bands).
- ( ) R2 is easy to install -- there isn't one!
- ( ) R5: a 9-pin SIP (Single Inline Plastic) black part with eight 100k resistors in it (marked "L91S104"). Note the end with the white line; this is "pin 1". Place it on the board at location R5 with the pin 1 end next to C4. Bend two of the leads slightly to hold it in place, then solder each lead, and cut off the excess.

Diodes: They are polarity sensitive, and have a black band at one end. Be **sure** the banded end matches the band shown on the board!

- ( ) D9: 1N4148 (a reddish glass tube, with a wire at each end, and "1N4148" printed on it in tiny letters). Bend the leads, and place it on the board at "D9" with the banded end as shown on the board. Solder each lead, and cut off the excess.
- ( ) D10: 1N4148. Install it the same as D9.
- ( ) D11: 1N5231B. Be sure it is the one that says "D11" on the lead. Install it the same as D9 and D10.

IC socket pins (or sockets): You have some choices here. Ideally, you don't need sockets or socket pins; they add cost, make the board higher, and a little less reliable (sockets will be the least reliable part of the whole computer). But having them makes troubleshooting and chip replacement easier.

- ( ) U1: 1802 integrated circuit. I supplied socket pins, which require some fussy work. They have an extremely low profile, but are tiny and easy to lose! Push a socket pin onto each pin of the 1802 IC. Put the 1802 with socket pins on the board, and then solder all the pins. Do **not** use too much solder, or it will solder the IC to the board! If you do it right, the 1802 can be unplugged from the board just like an IC in a socket. Do **not** cut the socket pins! The bottom needs to remain closed so solder won't get inside.

If you want to use your own IC socket, place it at location "U1" with the notched end matching the one shown on the board. Solder each pin, and cut off the excess. Install the 1802 in the socket (with pin 1 at the correct end).

- ( ) U2: memory chip (could be a RAM or EPROM, from 2k to 32k bytes). Install as described for U1 above.



Now let's do the rest of the ICs. I did not supply sockets or socket pins for them. They are not likely to fail, and the sockets cost more than the chips. You can add sockets if you like, but it is likely to increase the height.

**Don't** use el-cheapo sockets... they will cause more problems than they solve!

ICs are polarity sensitive; they **must** be installed with the pin 1 end matching the marking on the board. The pin 1 end may be marked in a number of ways; with a dot, notch, or line, etc. When the writing on the IC is right side up and facing you, pin 1 is at the lower left corner. See the illustration on page 6 to find pin 1.

For each IC, make sure its pins are straight and parallel to each other so it fits into the holes on the board. If they are bent slightly, straighten them with your needle-nosed pliers.

- ( ) U3: 74HC373 (or 74HCT373) 20-pin IC. Install at U3, and bend a couple pins slightly if necessary to hold it in place. Be sure pin 1 is at the correct end! Then solder all pins, and cut off the excess.
- ( ) U4: 4093 14-pin IC. Install the same as for U3.
- ( ) U5: 4013 14-pin IC.
- ( ) U6: 74HC244 (or 74AC244) 20-pin IC.
- ( ) U7: 74HC374 (or 74HCT374) 20-pin IC.

We're almost done. Now for the pin headers.

- ( ) P1: 30-pin header. The little square pins are held by a black plastic body. If you don't plan to put the boards in an Altoids tin, just put the header on the board, and solder it in place.

If you **DO** want it to fit in an Altoids tin, the plastic body **must** be removed. Here's how I did it:

- Hold the pin header loosely in a small vice, with the plastic body sitting on top of the jaws.
- Pound the short end of each pin into the plastic, so all of the pin sticks out the other side.
- Insert the pin header from the **BACK** side of the board, with the plastic body about 1/8" away from the bottom of the board (so the pins stick up about 1/4" above the top of the board).
- Solder each pin from the **TOP** side of the board.
- Cut each pin on the **BACK** side of the board. This also removes the black plastic body.

- ( ) P2: 5-pin header. Mount P2 the same as P1. The pins **must** not stick up more than 1/4" above the board.
- ( ) P3: 6-pin header. I supplied an 8-pin part. Remove 2 of the pins so it will fit on the board. Mount it the same as J1 and P2. The pins **must not** stick up more than 1/4" or they will short to the Front Panel board.
- ( ) Q1: MOSFET transistor (2N7000). This is also a static sensitive part, so beware of static electricity. Position the flat side of the body to match the outline on the board. Put each lead in its respective hole (numbered 1, 2 and 3). This addresses memory at 0-32k. Solder Q1 and cut off the excess lead length.

Note: Rev.D and later boards have **TWO** ways to mount Q1 (see schematic on page 18). Put the leads of Q1 in holes 1, 3, and 4 to address memory at 32-64k if this is a **second** board. This lets you to stack \*two\* Membership Cards, parallelling them via the 1802 socket, to put one memory chip at 0-32k, and the second at 32-64k.

## Front Panel assembly

( ) A. If you have no Cover Card, use the bare front panel board as a template to drill your front panel (an Altoids tin, or your own plastic or metal one). I use the **bottom** of the Altoids tin as my "front panel". Drill small 1/32" holes for the switches, LEDs, D-connector mounting holes, and 4-pin power connector P4. Then remove the PC board, and drill these holes to their final sizes. Use a "step" drill bit, which won't tear the very thin metal (this is a long drill bit with a single cutting edge and steps in it to drill a dozen or so sizes from 1/8" to 1/2"). Cut the D-connector opening with a nibbling tool or a lot of hand filing.

B. If you have the optional **Cover Card**, it has all the holes and silkscreened labels (see photo on page 3). Just cut a big ragged hole in the Altoid tin; lay this card over the hole; and solder, screw, or glue it in place. The Cover Card is \$10 plus \$2 shipping from me (Lee Hart); see contact info on the cover.

( ) S11: Pushbutton switch. Place it on the board with the side marked "120vac" UP in this picture. Bend one of the pins slightly; just enough so it won't fall off the board.  
Do not solder it yet.

( ) S10: Toggle switch. Install it the same as S11, with the "120v" side up, and bend a pin so it won't fall off.  
Do not solder it yet.

( ) S9-S0: Place them on the board the same as S10.  
Do not solder them yet.

( ) D8: LED. Place it on the board, with the short lead and flat side on the right as shown.  
Bend a lead slightly so it won't fall off.  
Do not solder it yet.

( ) D0-D7: LEDs. Install as for D8 above.

( ) J2: D-connector. Temporarily mount to the COVER CARD or YOUR FRONT PANEL with the #4 hardware provided. The side with the most pins goes toward the top.

Dev4FP-A.bmp

( ) Now, fit the PC board with the LEDs and switches into the holes in your front panel or the Cover Card. Work the board as close as you can to the metal panel. This moves all the parts into the correct positions to match your front panel holes. Careful! The switches can break if your front panel holes don't match the board well enough. **NOW** solder the parts to the board, with the front panel holding them all in position.

( ) Remove the screws from the D-connector. Remove the PC board from the panel, so you can install the rest of the parts. The above may seem tedious, but it guarantees that the parts will be soldered in the right positions to match the holes in your front panel. :-)

( ) J1a, J1b, J1c: Mount these connectors on the **BOTTOM** of the Front Panel board. Three 10-pin parts are supplied. The two "feet" face the center of the board. Cut them off after the connectors are mounted.

- ( ) R11: 10-pin SIP resistor network with nine 1K resistors (black, marked "L101S102"). The end with the black dot or line is "pin 1", and goes on the LEFT end, toward the center of the board. Solder each lead and cut off the excess.

Install R12 and R13 exactly the same as R11:

- ( ) R12: 8-pin SIP with seven 100K resistors (black, marked "8A104G").
- ( ) R13: 8-pin SIP with seven 100K resistors (black, marked "8A104G").

Install the diode, fixed resistors, and capacitor as was done on the Membership Card:

- ( ) D12: 1N4148. Be sure the end with the black band matches the band on the board.
- ( ) R8: 499k 1% (brown body, with yellow-white-white-orange-brown bands).
- ( ) R9: 499k 1% (brown body, with yellow-white-white-orange-brown bands).
- ( ) R10: 499k 1% (brown body, with yellow-white-white-orange-brown bands).
- ( ) R14: 6.8k 1% (blue body, with blue-gray-black-brown-brown bands).
- ( ) C7: 0.1uF (yellow, marked "104").

Install the ICs the same way as U3-U7 on the Membership Card. Be sure pin 1 is as shown on the board:

- ( ) U8: 4071 14-pin IC.
- ( ) U9: 74HC257 16-pin IC.
- ( ) P4: 4-pin header. Install as described for J1 on the Membership Card. Or if you prefer, leave off P4 and solder 4 small wires to the board instead, with a connector on the other end.
- ( ) Check to see that the finished board still fits into the holes in your front panel. You may have to re-heat and reposition some parts, or enlarge some holes in your front panel to make it fit easily.
- ( ) The last page of this manual is a "cheat sheet" summary of operation. Cut out one vertical column, and fold it to fit inside the Altoids box. It's a handy reminder, and also keeps the pins on the back of the board from shorting to the metal case!

## Final Assembly

Next, install jumpers on the Membership Card to configure it for the size and type of memory chip at U2:

- ( ) P2 and P3: Look at the type of memory chip installed at U2. Ignore the letters at the beginning and end of the part number, and focus on the 4-digit or 5-digit number in the center. For example, suppose it is marked "HM62256P-12" -- then it's a 62256 (a 32k byte RAM).
- ( ) Find the table at the bottom left corner of the schematic. Look up your chip number to see what jumpers to install. For a 62256, install jumpers at P2 between pins 1-2 and 4-5, and P3 between pins 1-3 and 2-4.
- ( ) A/B Jumper: Short A/B if you want to plug J2 into a PC's parallel port. Leave A/B open, and short Q0, Q1, Q2, and Q3 if you want to use J2 as a general-purpose I/O port with all eight OUT4 bits on J2.

- ( ) Plug the Membership and Front Panel boards together. Look between them for any places where parts touch each other and could cause a short. Trim any leads that are too long and might touch.
- ( ) Your switches may have threaded bushings with nuts and washers, or just plain bushings (it depends on which switches I had in stock at the moment). There really isn't enough room for nuts anyway, so don't bother with them unless you feel the boards need the support. The hardware for J2 usually does the job.

## Power On!

Now it's time for the smoke test! We'll connect power, and try not to let any of the magic smoke out. (Old timers will tell you that electronic devices don't work after smoke comes out.)

The Membership Card takes very little power; 3v to 5v DC at under 1ma (plus 2-3ma for each LED that is lit). You can use a few 1.5v batteries, an old cellphone charger that outputs 5vdc, or even a solar panel from a scrapped calculator for power. For example, a battery holder with three AA cells in a second Altoids tin.

R1 sets the clock frequency (15 turns end-to-end). Fully counterclockwise is very slow, but very low power. Fully clockwise is maximum speed, which is OK with a 5v supply but too fast with a 3v supply. C1 is a ceramic resonator; it will "lock in" to 1.8 MHz with R1 adjusted fully clockwise and then counterclockwise 1/2 turn.

Zener diode D11 is an "idiot" diode. If power is connected backwards, or is over 5.1 volts, or is AC instead of DC, then D11 shorts it out to protect the rest of the board. At worst, D11 will get hot and fail shorted; but it's cheap and easy to replace. Or, you can apply power to pin 18 of D-connector J2. It has a diode in series (D12), so a reversed supply voltage or AC won't hurt anything.

P4 is the power connector. It's a common male header with four 0.025" square pins on 0.100" centers, located in the top left corner of the Front Panel board. There are many mating connectors. For example, the 4-pin cable used in PCs between the CDROM drive and sound card can be used. Other choices include:

- Molex KK series: 22-01-3047 housing, 08-55-0102 terminals ([www.jameco.com](http://www.jameco.com) 234819, 234931).  
Common and easy to use, but not latched or keyed.
- AMP-latch series: 25403S-04 header, 25403H-04-R housing, 25403T terminals ([www.jameco.com](http://www.jameco.com) 152734, 152741, 181673). Higher quality, latched and keyed (if you use its header); but hard to install terminals.

### P4 pin Name Function

1	+	VDD (or VCC), the power supply positive; +3 to +5 volts DC.
2	RUN	Controls the 1802's clock oscillator. Connect to pin 1 to Run; leave pin 2 open to Stop.
3	LED	LED negative. Connect to pin 4 to enable the LEDs; leave pin 3 open to disable the LEDs.
4	-	VSS (or ground, common), the power supply negative.

Pin functions are shown above. Your power connector should connect your power supply's positive to pins 1 and 2, and negative to pins 3 and 4. To turn "on", plug it onto the board to make + and RUN high (clock runs), and - and LED low (LEDs enabled). To turn "off", unplug the connector; RUN goes low, the clock stops, and the LEDs are disconnected to minimize power. Supercapacitor C4 will hold the program and data for many minutes.

On Rev.D and later boards, D-connector J2 pin 18 can also be used for your VDD power input (via diode D12). OK; you have power connected (and nothing smokes). Let's continue, and see if it's working!

To maintain a program and data in RAM indefinitely, leave power connected to P4 pins 1 and 4. Use a DPST (double pole, single throw) switch to break the connections between pins 1-2 and 3-4. This switch provides "on" and "sleep" modes. "On" enables the clock and LEDs to work normally. "Sleep" holds memory contents but makes the power supply current very low; a set of AA cells will maintain memory for a year. If the Front Panel is connected, it over-rides "Sleep" mode unless you also set CLEAR and data switches D0-D7 all low.

## Operation

The Front Panel selects the 1802's operating mode and shows its status. The eight Data switches S7-S0 set the data to be input. S12 is the IN pushbutton; pressing it loads the data. Data LEDs D7-D0 display the last data loaded or output by the 1802 program. LED D8 shows the status of the 1802's "Q" register.

S8 is the READ/WRITE switch; it controls whether you can read or write to memory. S9 and S10 are the mode switches, CLEAR and LOAD. They select the four operating modes as follows:

	S9	S10	
<u>Mode</u>	<u>CLEAR</u>	<u>LOAD</u>	<u>1802 Operation</u>
LOAD	down	down	Waits for the next memory read/write (next press of the IN button).
CLEAR	down	up	Reset the 1802 (sets registers Q, X, P, and R0 all to 0).
WAIT	up	down	Stops the program running in memory, and waits right where it is.
RUN	up	up	Runs (or resumes running) the program in memory.

Here's an example of how these switches and lights work.

1. Power up the card. Set switches S11-S0 as shown. "1" means the switch is up. "0" means the switch is down. "X" means push the button. "." means the switch state doesn't matter. I'll show the switch positions like this:

Switch numbers and positions on the board

<u>S11</u>	<u>S10</u>	<u>S9</u>	<u>S8</u>	<u>S7</u>	<u>S6</u>	<u>S5</u>	<u>S4</u>	<u>S3</u>	<u>S2</u>	<u>S1</u>	<u>S0</u>	<u>Mode</u>	<u>Description</u>
.	1	0	.	.	.	.	.	.	.	.	.	CLEAR	Resets the 1802.

### PROGRAM 1 -- BLINK Q FAST

Let's load a simple program to blink the "Q" LED:

	<u>S11</u>	<u>S10</u>	<u>S9</u>	<u>S8</u>	<u>S7</u>	<u>S6</u>	<u>S5</u>	<u>S4</u>	<u>S3</u>	<u>S2</u>	<u>S1</u>	<u>S0</u>	<u>Mode</u>	<u>Description</u>
2.	.	1	0	.	.	.	.	.	.	.	.	.	CLEAR	Reset the 1802 (sets R0 to address 0000).
3.	.	1	0	1	.	.	.	.	.	.	.	.	WRITE	Set S8 up, so we can write to memory.
4.	.	0	0	1	.	.	.	.	.	.	.	.	LOAD	Set both S9 and S10 down.
	X	0	0	1	0	1	1	1	1	0	1	1	a.	Set S7-S0 to "0111 1011", then press the IN button. This loads hex 7B (the SEQ or "Set Q" instruction) into memory address 0000, displays it in the LEDs, then advances R0 from address 0000 to 0001.
					⌞	7	⌞			⌞	B	⌞		

```

X 0 0 1   0 1 1 1 1 0 1 0
           \_7\_/  \_A\_/

X 0 0 1   0 0 1 1 0 0 0 0
           \_3\_/  \_0\_/

X 0 0 1   0 0 0 0 0 0 0 0
           \_0\_/  \_0\_/

```

- b. Set S7-S0 to "0111 1010", then press IN. This loads hex 7A (the REQ or "Reset Q" instruction) into 0001, displays it, then advances R0 to 0002.
- c. Set S7-S0 to "0011 0000", then press IN. This loads hex 30 (BR or "Branch Unconditionally") into 0002, displays it, then advances R0 to 0003.
- d. Set S7-S0 to "0000 0000", then press IN. Loads hex 00 (tells "Branch Unconditionally" where to jump; in this case, back to 0), displays it, then advances R0 to 0004.

Our program is loaded. Let's read it back to see if it is correct.

	<u>S11</u>	<u>S10</u>	<u>S9</u>	<u>S8</u>	<u>S7</u>	<u>S6</u>	<u>S5</u>	<u>S4</u>	<u>S3</u>	<u>S2</u>	<u>S1</u>	<u>S0</u>	<u>Mode</u>	<u>Description</u>
5.	.	1	0	.	.	.	.	.	.	.	.	.	CLEAR	Reset the 1802 (sets R0 to address 0000).
6.	.	1	0	0	.	.	.	.	.	.	.	.	READ	Set S8 down, so we can read memory.
7.	.	0	0	0	.	.	.	.	.	.	.	.	LOAD	Set both S9 and S10 down.
	X	0	0	0	0	1	1	1	1	0	1	1	a.	Press the IN button. This reads memory address 0000, displays its contents in the LEDs ("0111 1011" which is hex 7B) then advances R0 from address 0000 to 0001.
					\_7\_/					\_B\_/				
	X	0	0	0	0	1	1	1	1	0	1	0	b.	Press IN again. Displays "0111 1010" = hex 7A from address 0001, then advances R0 from 0001 to 0002.
					\_7\_/					\_A\_/				
	X	0	0	0	0	0	1	1	0	0	0	0	c.	Press IN again. Displays "0011 0000" = hex 30 from address 0002, then advances R0 to 0003.
					\_3\_/					\_0\_/				
	X	0	0	0	0	0	0	0	0	0	0	0	d.	Press IN again. Displays "0000 0000" = hex 00 from address 0003, then advances to 0004.
					\_0\_/					\_0\_/				

If our program is correct, now we can run it!

8.	.	1	0	.	.	.	.	.	.	.	.	.	CLEAR	Reset the 1802 (set R0 back to address 0000).
9.	.	1	1	.	.	.	.	.	.	.	.	.	RUN	Both S9 and S10 up. The 1802 begins running the program starting at address 0000.

This program is very simple; it tells the 1802 to turn the Q LED on, then off, and repeat forever. But it's doing it so fast that the LED looks half on. To prove it's really going on and off, connect a pair of headphones or a small speaker between J2 pin 15 (Q) and pin 20 (ground); you'll hear an audio tone! Adjusting R1 changes the pitch.

Or, we can use the WAIT mode to temporarily stop the program.

10.	.	0	1	.	.	.	.	.	.	.	.	.	WAIT	Stop right where you are! The 1802 "freezes" where it is in the program. The Q LED may be caught on, or off.
-----	---	---	---	---	---	---	---	---	---	---	---	---	------	--

Flipping S10 up and down will RUN and WAIT the program, sometimes catching Q on, sometimes off. WAIT is handy for debugging; you can check the state of any line with a meter or logic probe to see what is going on.

Here's a bit longer program. It does the same thing (blinks Q), but much slower. Use the same sequence of switch flipping as above. Let's simplify the description so it's not so wordy. See if you can figure out how to enter it. (Hint: There's a "cheat sheet" at the end of the manual).

**PROGRAM 2 -- BLINK Q SLOW**      Blink the Q LED slowly.

address	machine code			
<u>(R0)</u>	<u>Hex</u>	<u>Binary</u>	<u>mnemonic</u>	<u>human readable comments</u>
0000	7B	0111 1011	SEQ	SEt Q
0001	FC	1111 1100	ADI	ADd Immediately...
0002	01	0000 0001	1	...1
0003	3A	0011 1010	BNZ	Branch if Not Zero...
0004	00	0000 0000	0	...to address 0
0005	7A	0111 1010	REQ	REset Q
0006	FC	1111 1100	ADI	ADd Immediately...
0007	01	0000 0001	1	...1
0008	3A	0011 1010	BNZ	Branch if Not Zero...
0009	05	0000 0101	5	...to address 5
000A	30	0011 0000	BR	BRanch unconditionally...
000B	00	0000 0000	0	...to address 0

The 1802 is an 8-bit microprocessor; 255 is the biggest number it can represent with 8 bits. The instructions from 0000 to 0004 are a loop; it counts up until it hits 255. Then, 255+1 makes it "roll over" back to 0 again. This satisfies the Branch instruction at 0003, so it stops looping and continues with the instruction at 0005.

This turns Q off, and loops another 255 times until the counter rolls over again from 255 to 0. The unconditional branch at 000A makes it start all over again. But even though Q is blinking 256 times slower, it's **still** too fast to see! Turn R1 fully counterclockwise (10 turns) to slow the clock way down; then Q blinks about once a second.

**PROGRAM 3 -- READ SWITCHES AND DISPLAY VALUE IN LEDS**

Here's a little more complicated program. It reads the 8 data switches, and displays their settings on the 8 LEDs. It tests the Membership Card's ability to read and write to the switches and lights. Run it with S8 up (write).

address	machine code			
<u>(R0)</u>	<u>Hex</u>	<u>Binary</u>	<u>mnemonic</u>	<u>comments</u>
0000	E1	1110 0001	SEX 1	Set X register to 1 (OMG! 1802's have sex instructions)
0001	90	1001 0000	GHI 0	Get HIgh byte of register 0 in D (sets D=0)
0002	B1	1011 0001	PHI 1	Put D in HIgh byte of register (so R1=00xx)
0003	F8	1111 1000	LDI	Load D Immediately with...
0004	10	0001 0000	10h	...10 hex
0005	A1	1010 0001	PLO 1	Put LOW half of R1=D (so R1 is now 0010)
0006	6C	0110 1100	INP 4	INPut port 4 (front panel switches) & write into memory at (R1)
0007	64	0110 0100	OUT 4	OUTput to port 4 (front panel LEDs) contents of memory at (R1)
0008	30	0011 0000	BR	BRanch unconditionally...
0009	00	0000 0000	0	...to address 0000

## Last Writes

I'm still working on this manual; more illustrations, better assembly directions, instructions for troubleshooting, hookup, and ways to load and save programs from your PC without all that flippin' switch flipping. Watch the websites listed below for the latest details!

I hope what I have so far is enough to get you going. If not, please feel free to contact me with comments, corrections, questions, or ways to improve it. My contact information is on the first page.

### Changes along the way:

July 2010: Rev.A board: Changed R8-R10 from 100k to 470k.

Aug 2010: Rev.B: Added Q1 and C6. Changed I/O port from 5/7 to 4/5/6/7 to match Elf. Added RUN to P4.

Nov 2010: Changed R4 and R8-10 from 470k to 499k, and C6 from 82pf to 100pf (for expediency; I ran out of 470k and 82pf parts, and have lots of 499k and 100pf).

Jul 2011: Rev.C board: Fixed silkscreen I/O port names; was IN5/7, now INP4; was OUT5/OUT7, now OUT4. (No hardware changes; IN and OUT ports still respond to any port number from 4-7). Moved a few parts to reduce solder shorts. Made a "Cover Card" to mount on top of Altoids box for a finished appearance.

Aug 2011: Corrected P2 jumper chart on schematic. For 6116, 2716, 2732; P2 was 2-3, changed to 3-4. For 2764; P2 was 3-4, changed to 2-3. For 27128 and 27256; P2 was 1-2 and 3-4, changed to 2-3 and 4-5.

Sept 2011: Added power supply info.

Jan 2012: Added photos of finished boards.

Mar 2012: Added "cheat sheet" summary page.

Apr 2012: R1 changed from 1meg to 500k (I ran out of 1meg pots).

June 2012: Rev.D board: R1 changed back to 1meg. R2 changed to 5.6k (to raise maximum clock frequency).

Added D12 (so power is available on DB25 connector J2). Added R14 (to use J2 pin 1 for serial input).

Added jumpers A/B, Q0, Q1, Q2, and Q2 (to use J2 for general purpose I/O instead of PC parallel I/O).

Aug 2012: Ran out of parts; so changed C5 from 0.047F to 0.022F, and R2 and R14 from 5.6k to 6.8k.

Jan 2013: Rev.E board: Made room for a bigger supercapacitor at C5 (now 0.22F).

May 2013: Rev.F board: Changed C1 to ceramic resonator (more stable frequency). Removed R2 to make room.

## Links for more data on the 1802 and ELF computers:

<http://www.sunrise-ev.com/MembershipCard.htm>

This is my website, with ordering information, manual updates, schematics, cheat sheets, and more.

[http://incolor.inebraska.com/bill\\_r/elf/html/elf-1-33.htm](http://incolor.inebraska.com/bill_r/elf/html/elf-1-33.htm)

This is the Aug 1976 Popular Electronics article that introduced the ELF to hobbyists. Most of it applies directly to the Membership Card.

[http://datasheets.chipdb.org/RCA/MPM-201B\\_CDP1802\\_Users\\_Manual\\_Nov77.pdf](http://datasheets.chipdb.org/RCA/MPM-201B_CDP1802_Users_Manual_Nov77.pdf)

An online copy of RCA's User Manual for the 1802. "Must read" reference material!

<http://www.ittybittycomputers.com/IttyBitty/ShortCor.htm>

"A Short Course in Programming, by Tom Pittman. An excellent introduction to programming the 1802.

<http://www.cosmacelf.com>

The COSMAC ELF "fan club", with lots of information on the many commercial and hobbyist variants.

<http://www.retrotechnology.com/memship/memship.html>

Herb Johnson's website on the Membership board. He built one of the first ones, and has done a great job documenting it (many thanks, Herb)! There are design notes, history, software examples, etc.



# "Mugshots" of the Elf Membership Card 3-board Set

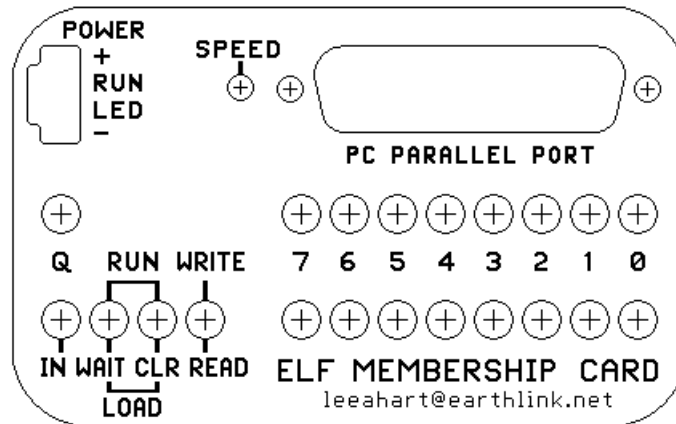

Cover Card (1:1 scale): Can use as a drilling template.

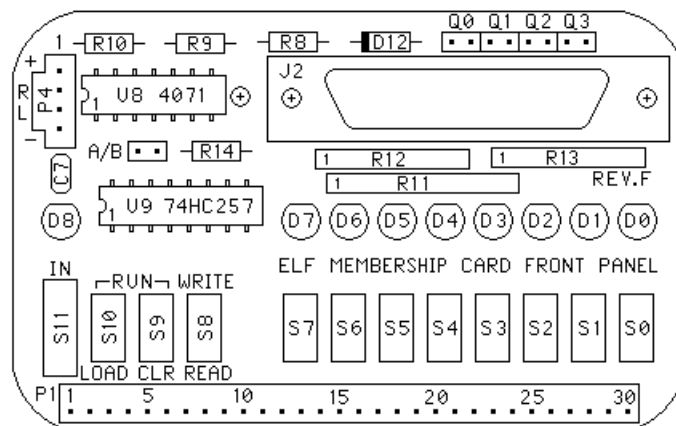

Front Panel Card (1:1 scale): Part location and placement guide.

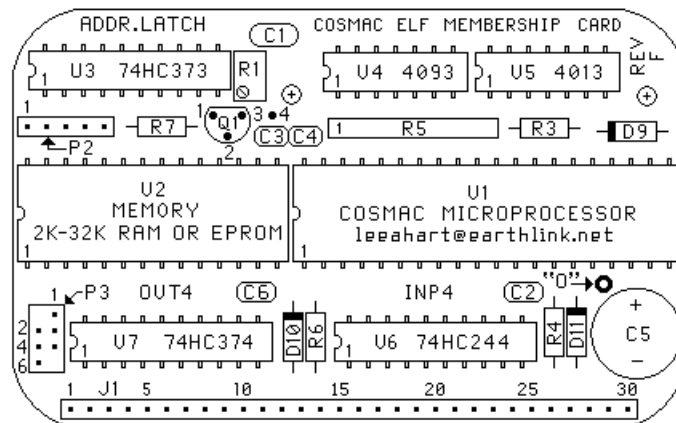

Membership Card (1:1 scale): Part location and placement guide.

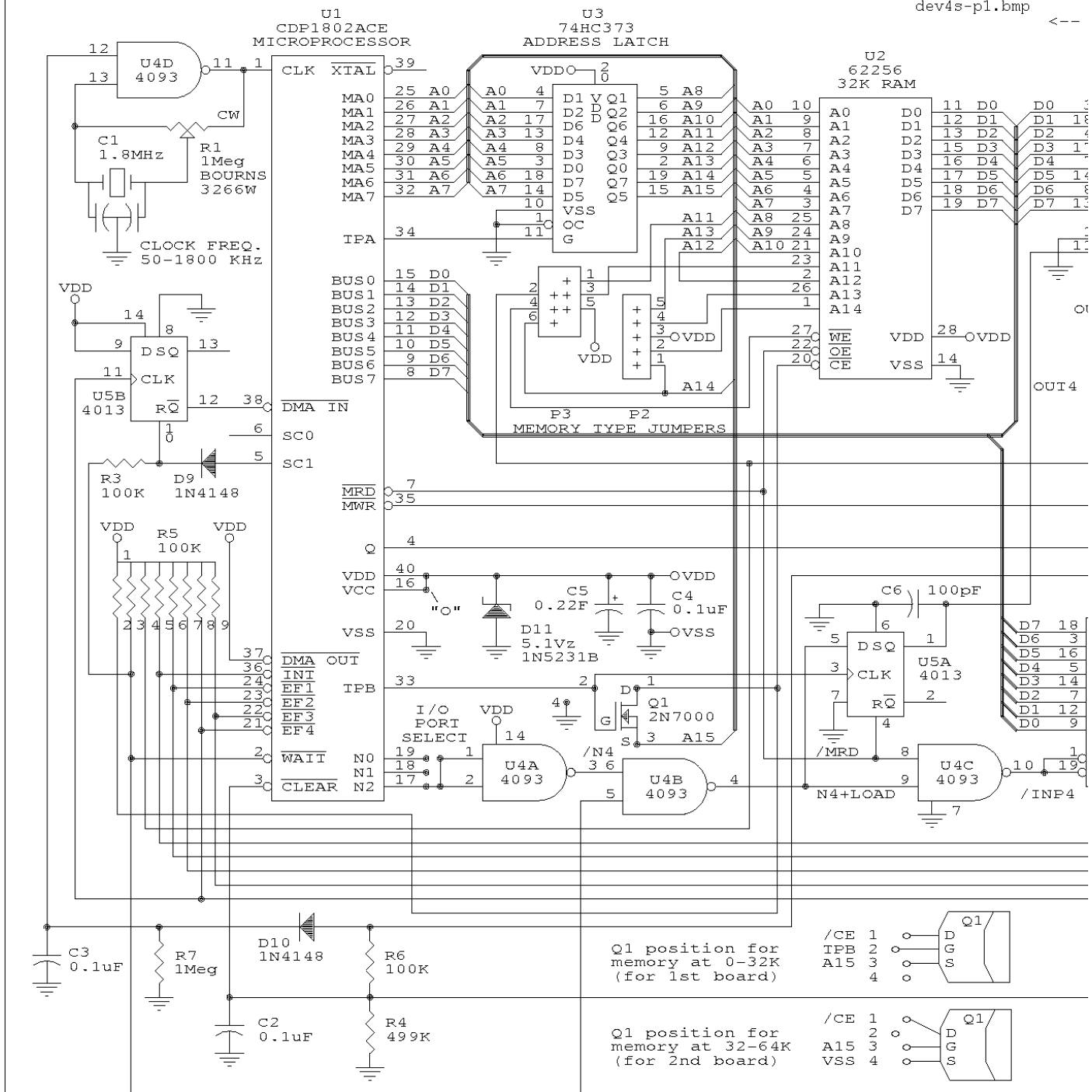

U2 part#	pin#s:	1	23	26	27	F2	Jumpers	F3
43256,62256	32K RAM	A14	A11	A13	/WE	1-2, 4-5	1-3, 2-4	
6264	8K RAM	A11	VCC	VCC	/WE	3-4	1-3, 2-4	
6116	2K RAM	/WE	VCC	VCC		3-4	2-3	
27256	32K ROM	VCC	A11	A13	A14	2-3, 4-5	1-3, 4-6	
27128	16K ROM	VCC	A11	A13	VCC	2-3, 4-5	1-3, 4-5	
2764	8K ROM	VCC	A11	NC	VCC	2-3	1-3, 4-5	
2732	4K ROM	VCC	A11	VCC		3-4	1-3	
2716	2K ROM	VCC	VCC	VCC		3-4	3-5	

\* is a 24-pin chip: put its pin 1 into socket pin 3.  
 P4 power pin 1 VDD: +3 to +5 VDC (3 AA cells etc.)  
 connector pin 2 RUN: to pin 1 to run, open stops osc.  
 pin 3 LED: to pin 4 enables LEDs, open=off.  
 pin 4 COMMON for power (GND, VSS).

- Notes:
1. Uses C1-7 D0-12 J1-2 P1-4 Q1 R1 R3-1
  2. Boards stack; Front Panel on top, Me Card on bottom, both component side
  3. For 1804, drill feedthru "O" to oper
  4. To use J2, set S0-7, S9-11 UP, and S
  5. Rev.B: Add Q1 to gate U2 /CE with TE R8-10=470K was 100K. Add C6=82pF. RU Add feedthru "O". Change I/O port fr
  6. Rev.C: R4 and R8-10 were 470K, now 4
  7. Rev.D: R2 was 15K, now 6.8K. Add R14 names. Swap P1-J1 designators. Add : Add N0-N2 & Q1 options to stack 2 Me
  8. Rev.E: Increase C5 to 0.22F, add roc
  9. Rev.F: Remove R2. Replace C1 with 1.

<-- Membership Card | Front Panel Card -->

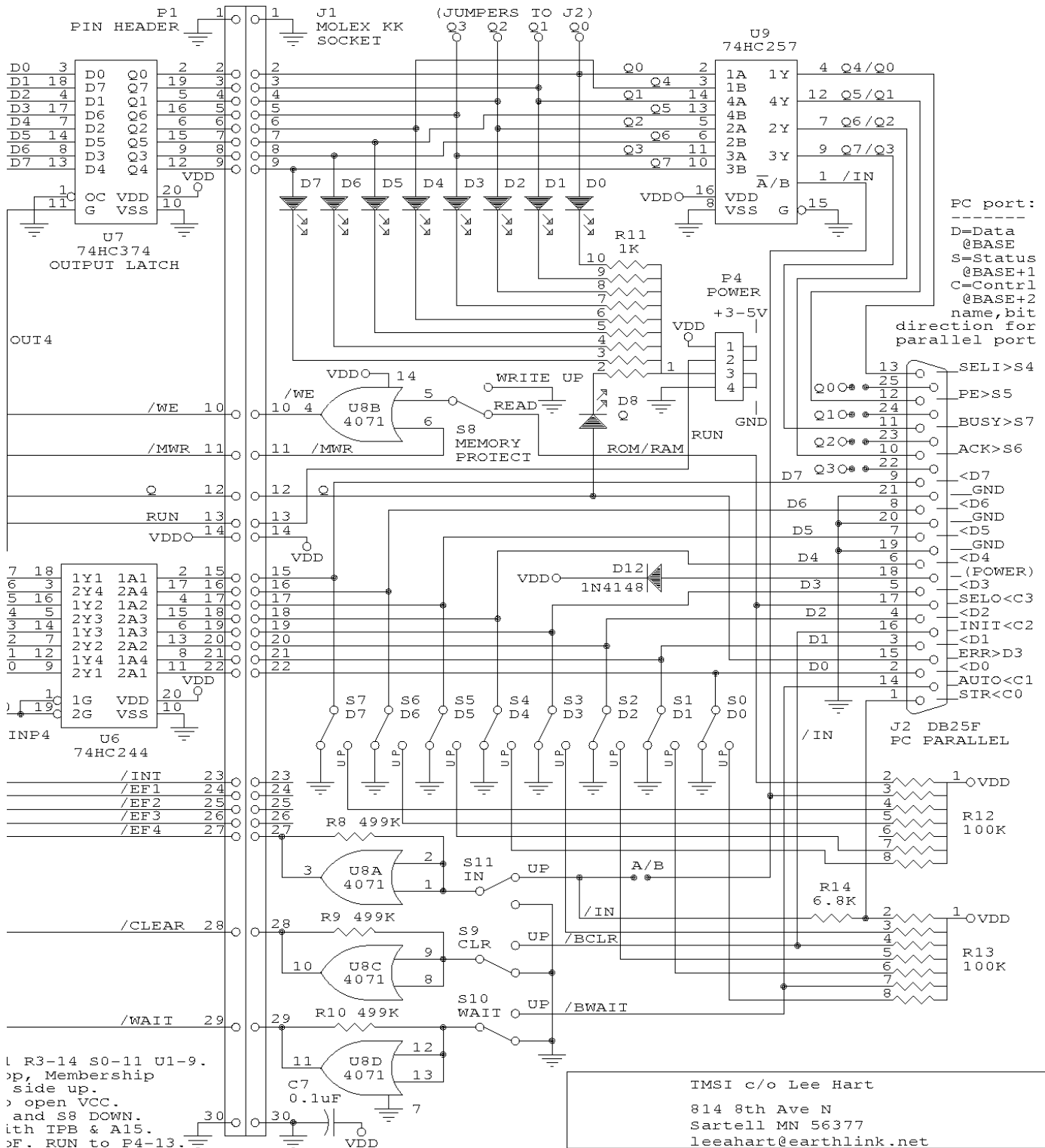

l R3-14 S0-11 U1-9.  
 op, Membership  
 side up.  
 open VCC.  
 and S8 DOWN.  
 ith IPB & A15.  
 F. RUN to P4-13.  
 rt from 5/7 to 4/5/6/7 (but silkscreen wrong).  
 now 499K. C6 was 82pF, now 100pF.  
 id R14 for RS-232 input. Add D12. Add J2 signal  
 Add jumpers A/B, Q0-Q3 for 8 outputs on J2.  
 : 2 Membership Cards w/o memory or I/O conflict.  
 id room for larger C5.  
 ith 1.8 MHz ceramic resonator.

IMSI c/o Lee Hart 814 8th Ave N Sartell MN 56377 leeahart@earthlink.net		
Title		
COSMAC ELF Membership Card (1 and 2 of 2)		
Size	Document Number	REV
B	C:\ORCAD\SHEET\1802\DEV4F.SCH	F
Date:	May 12, 2013	Sheet 1 of 1

